

M12 MALE / M12 FEMALE 0° SHIELDED

PUR 8x0,25 shielded GRAY, UL/CSA, drag ch 2m

Male straight – female straight

M12 – M12, 8-pole

shielded

Plastic housings with good resistance against chemicals and oils.

The resistance to aggressive media should be individually tested for your application. Further details on request.

Further cable lengths on request.

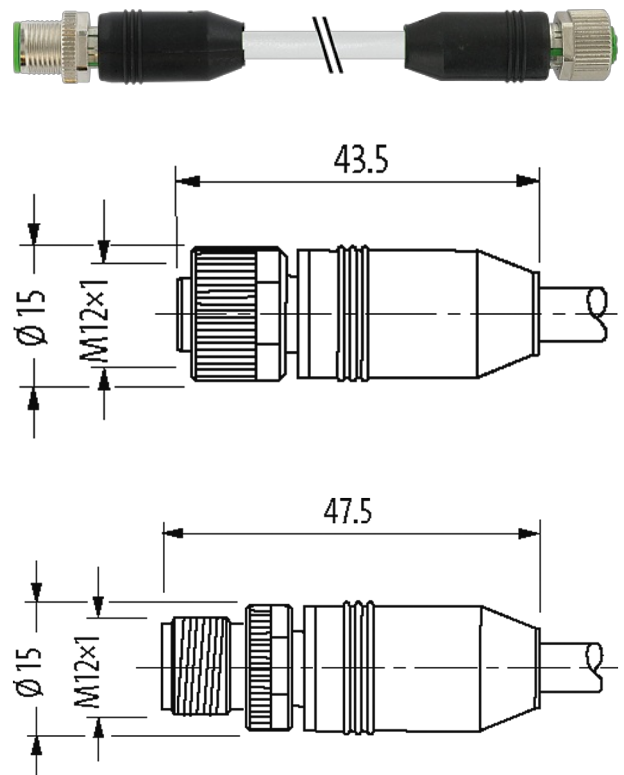
Link to Product**Illustration**

Product may differ from Image

Approvals

* only for products with UL/CSA approved cable

cCSAus

Form

Form 48041

General data

Standards DIN EN 61076-2-101 (M12)

Temperature range -25...+85 °C, depending on cable quality

CablesNo./diameter of wires 8 × 0.25 mm²

Wire isolation	PP (br, wh, bl, bk, gr, pk, vi, or)
C-track properties	5 Mio.
Material (jacket)	PUR (UL/CSA)
Outer Ø	7.0 mm ±5%
Bend radius (moving)	10× outer Ø
Temperature range (fixed)	-40...+80 °C
Temperature range (mobile)	-25...+80 °C
Cable identification	294
Cable Type	3 (PUR)
Approval (cable)	cURus (AWM-Style 20549/10493); CE conform
Cable weight [g/m]	74,80
Material (wire)	Cu wire, bare
Resistor (core)	max. 79 Ω/km (20 °C)
Single wire Ø (core)	0.1 mm
Construction (core)	32× 0.1 mm (multi-strand wire class 6)
Diameter (core)	8× 0.25 mm ²
AWG	similar to AWG 24
Material (wire isolation)	PP
Material property (wire isolation)	CFC-, halogen-, cadmium-, silicone- and lead-free
Shore hardness (wire isolation)	70 ±5 D
Wire-Ø incl. isolation	1.2 mm ±5%
Color/numbering of wires	br, or, vi, pk, gr, bk, bl, wh
Stranding combination	8 wires twisted around central filler
Shield	yes
	min. 80%
Material (jacket)	PUR
Material property (jacket)	CFC-, halogen-, cadmium-, silicone- and lead-free, matt, low-adhesion, machine easy to process, abrasion-resistant, hydrolysis and microbial resistant
Shore hardness (jacket)	90 ±5 A
Outer-Ø (jacket)	7.0 mm ±5%
Color (jacket)	gray
chemical resistance	good resistance to oil, gasoline and chemicals (EN 60811-404)
thermal resistance	flame retardant UL 1581 VW1 / CSA FT1 / IEC 60332-1, IEC 60332-2-2
Nominal voltage	300 V AC
Test voltage	2000 V AC
Current load capacity	to DIN VDE 0298-4
Temperature range (fixed)	-40...+80 °C, (+90 °C at max. 10 000 operating hours)
Temperature range (mobile)	-25...+80 °C, (+90 °C at max. 10 000 operating hours)
Bend radius (fixed)	5× outer Ø
Bend radius (moving)	10× outer Ø
No. of bending cycles (C-track)	max. 5 Mio. (25 °C)
Traversing distance (C-track)	max. 5 m (horizontal)
Travel speed (C-track)	max. 3.3 m/s
Acceleration (C-track)	max. 5 m/s ²
Torsion stress	±30 °/m
No. of torsion cycles	max. 2 Mio. (25 °C)
Torsion speed	35 cycles/min
Jacket Color	gray

Technical Data

Operating voltage	max. 30 V AC/DC
Rated surge voltage	0.8 kV
Operating current per contact	max. 2 A
Locking of ports	Screw thread (M12×1 mm) recommended torque 0.6 Nm, self-securing
Compression gland	M12 (SW13)
Protection	IP65, IP66K, IP67 inserted and tightened (EN 60529)

Commercial data

country of origin	DE
customs tariff number	85444290
EAN	4048879139151
eClass	27279218
Packaging unit	1

Sketch

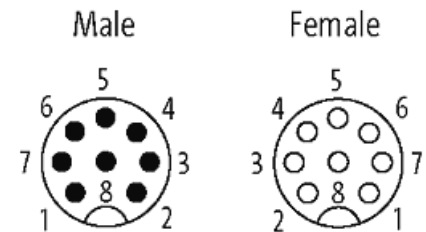

Product may differ from Image